

# MOBILATOR

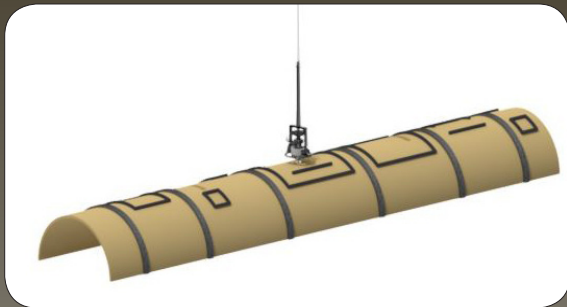

**Mobilator for rotary die**



**Mobilator for flat bed die**



**JIB crane**



**JIB crane telescoping**



**JIB crane articulated**



**bcm transtech as**

bcm transtech as • industrivej 60 • dk-5672 broby • denmark • phone: +45 62 63 23 93 • fax: +45 62 63 23 99  
www.bcmtranstech.com • e-mail: bcm@bcm.dk

***Mobilator rotary die***

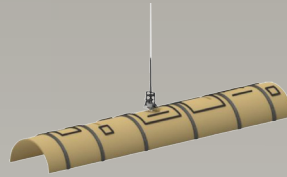

***Mobilator Flat bed die***



***JIB crane***



***JIB crane telescoping***



***JIB crane articulated***



## Mobilator for rotary dies



The Mobilator for the rotary dies is a fast and safe way to handle the rotary dies without any heavy lifting. The operator can easily move around and load the rotary die into the die cutting machine.

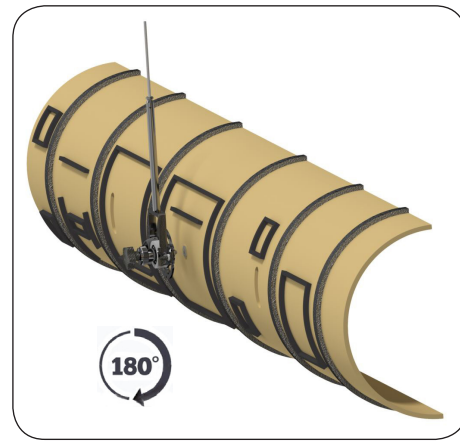
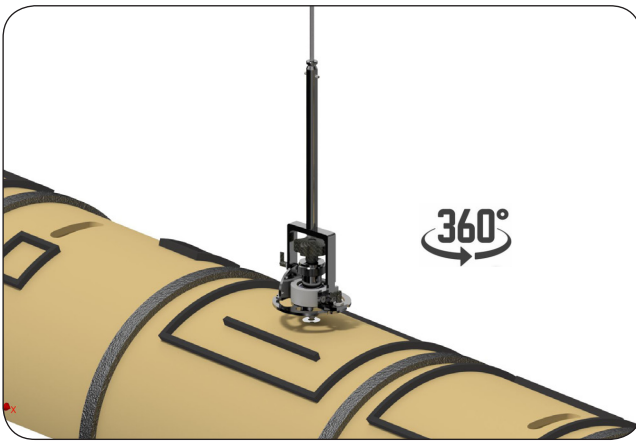

The mobilator handle is easy to mount on top of the rotary dies and makes the die rotatable 360° horizontal and 180° vertical. You also have the opportunity to lock<sup>1</sup> the rotary die when you are in motion or have the correct position to load the rotary die. A short operation of each rotary die is required to attach/fasten the Coil Nut<sup>2</sup>



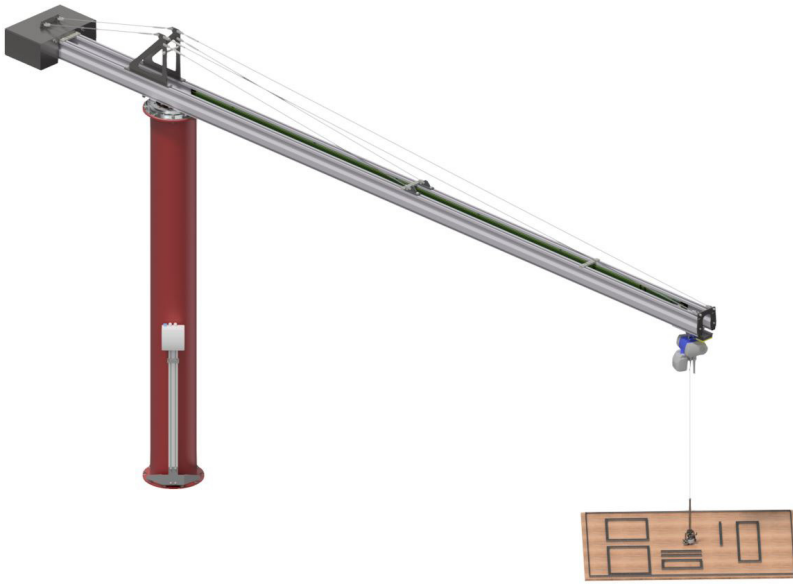

The Mobilator for the flat bed dies is an unique way to handle the dies on to the turntable and off again. You have also the opportunity to handle the stripping dies directly into the machine. This give you an easy and safe installation with no heavy lifting.

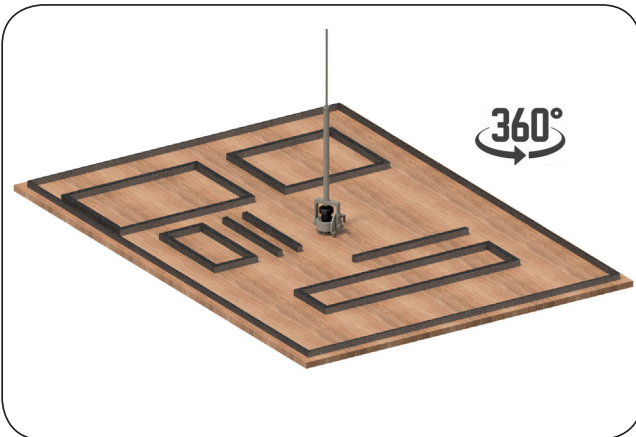

The Mobilator handle only needs a quick turn to secure the flat bed die on to the Mobilator. Now you have full controle and it is easy to rotate 360° horizontal and 180° vertical. You have also the opportunities to lock<sup>1</sup> the flat bed die horizontal or in vertical position. A short operation of each rotary die is required to attach/fasten the Coil Nut<sup>2</sup>



# Fact Sheet

## JIP crane

The JIB crane is an easy way to handle the Mobilator and a safe way to handle flat bed dies and rotary dies without any heavy lifting. It gives a large operation area and an easy installation.

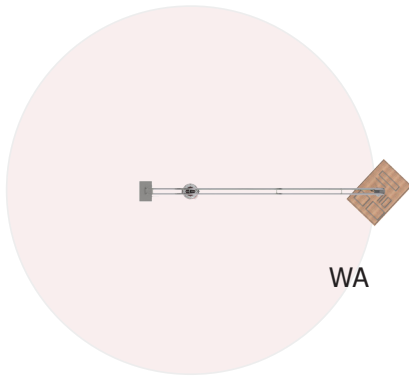
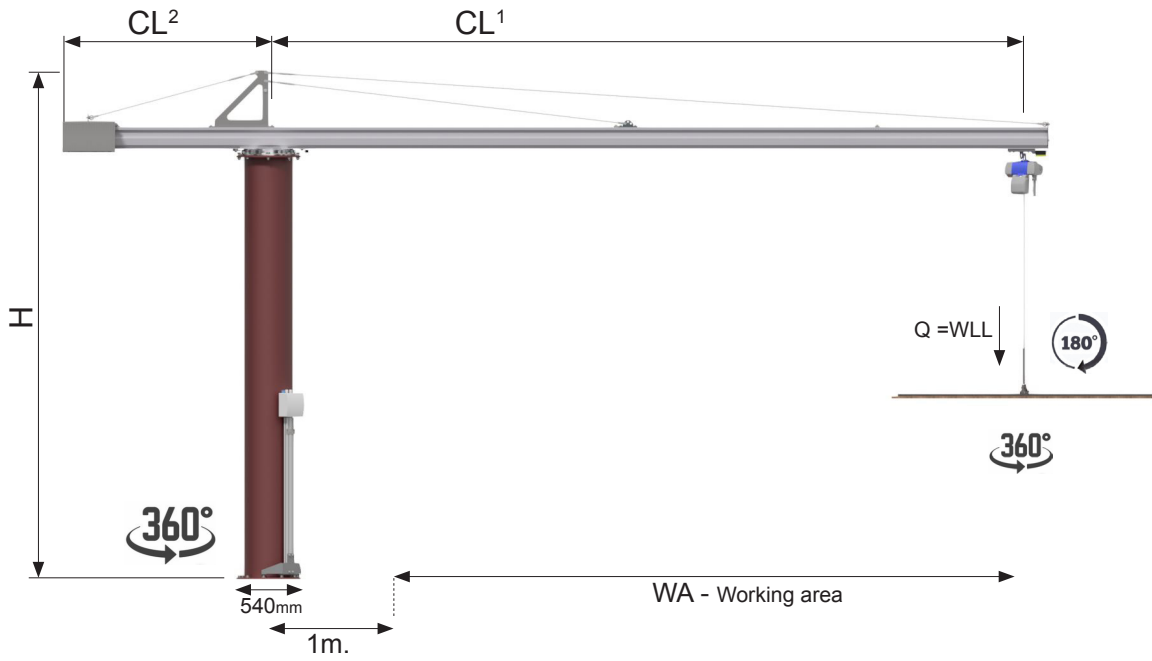

Mobilator	Measure/WLL
<ul style="list-style-type: none"> <li>• Q</li> <li>• <math>CL^1</math></li> <li>• <math>CL^2</math></li> <li>• H</li> <li>• WA</li> </ul>	<ul style="list-style-type: none"> <li>• 60 kg</li> <li>• 6500 mm</li> <li>• 1500 mm</li> <li>• 4200 mm</li> <li>• 6500 mm</li> </ul> <p>• Measure is based on a standard crane</p>

The JIP crane can be set up on almost all concrete floors and requires a minimum space of installation.

- Concrete floor is minimum 100 mm
- $f_2$  25 N/mm<sup>2</sup>
- Concrete must be free of cracks

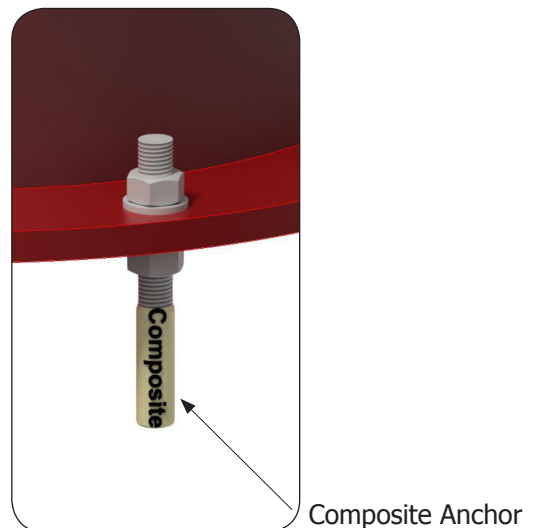
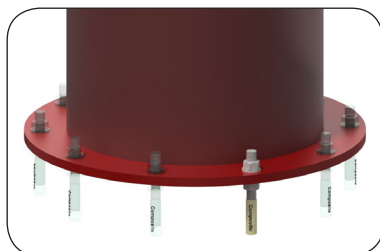

## JIP crane telescoping

The telescoping JIB crane gives you countless opportunities for handling the mobilator. You now have the possibility to bring the Mobilator into the die cutting machine and load or unload the rotary die safely and with out any heavy lifting.

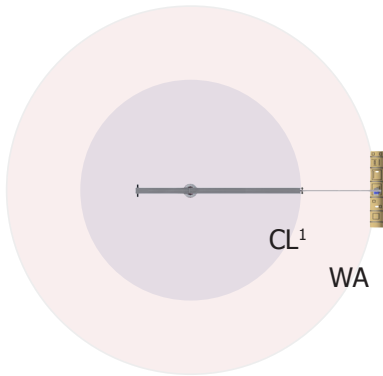
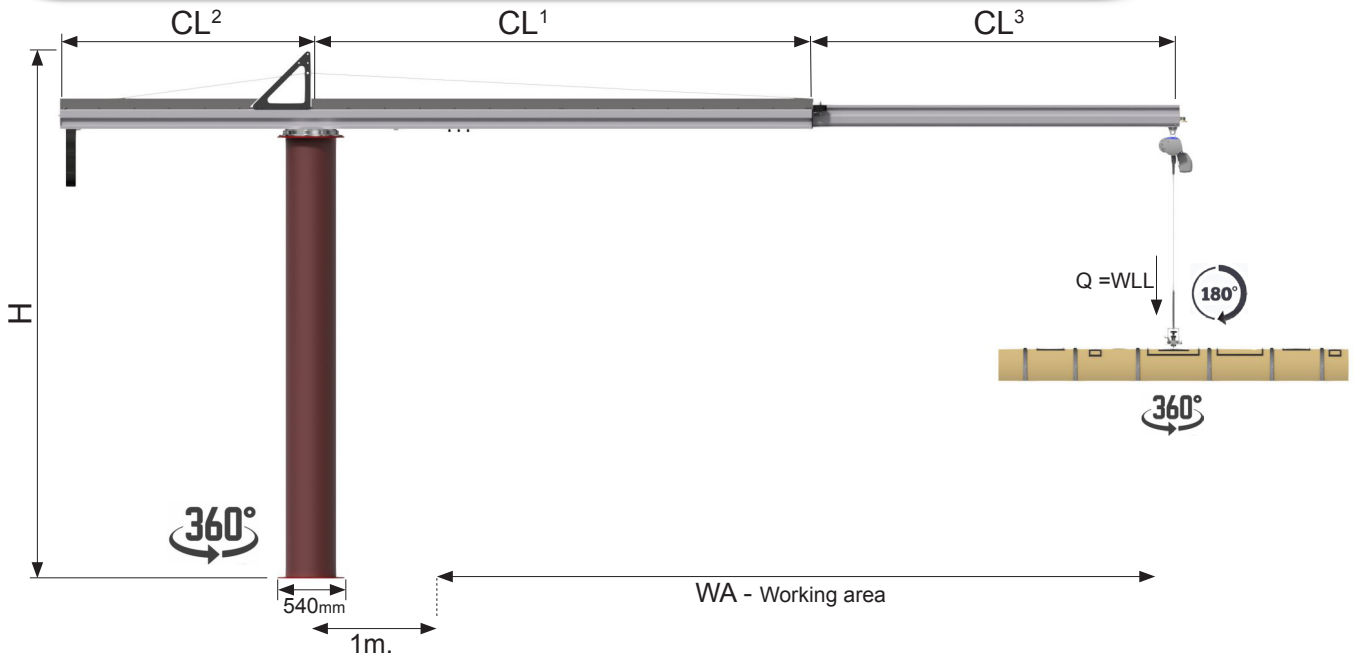

Mobilator	Measure/WLL
<ul style="list-style-type: none"> <li>• Q</li> <li>• CL<sup>1</sup></li> <li>• CL<sup>2</sup></li> <li>• CL<sup>3</sup></li> <li>• H</li> <li>• WA</li> </ul>	<ul style="list-style-type: none"> <li>• 60 kg</li> <li>• 4000 mm</li> <li>• 2000 mm</li> <li>• 3000 mm</li> <li>• 4200 mm</li> <li>• 6000 mm</li> </ul> <p>• Measure is based on a standard crane</p>

The JIP crane can be set up on almost all concrete floors and requires a minimum space of installation.

- Concrete floor is minimum 100 mm
- $f_2$  25 N/mm<sup>2</sup>
- Concrete must be free of cracks

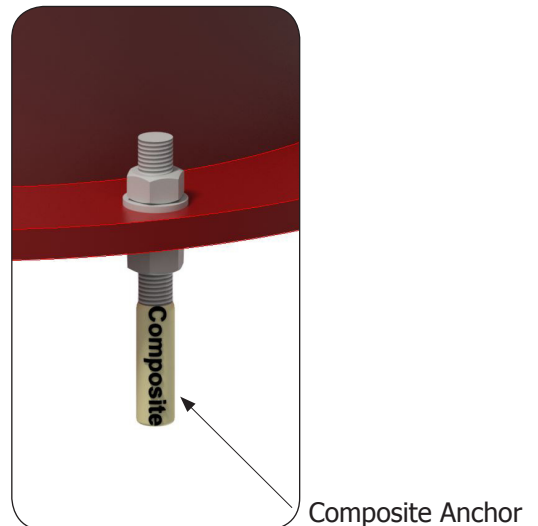
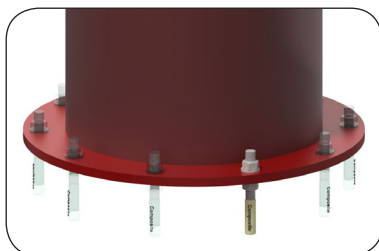

## JIP crane articulated

The JIP crane articulated gives a unique way to handle the Mobilator. You can operate the Mobilator in almost any directions and it is to handle the rotary dies or flat bed dies also where it is difficult to get access

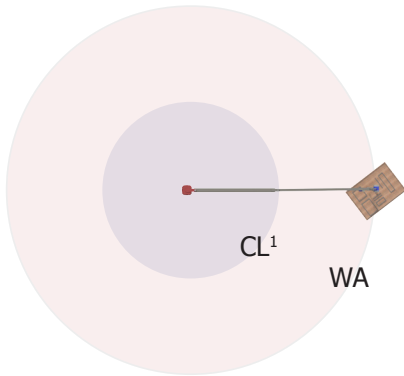
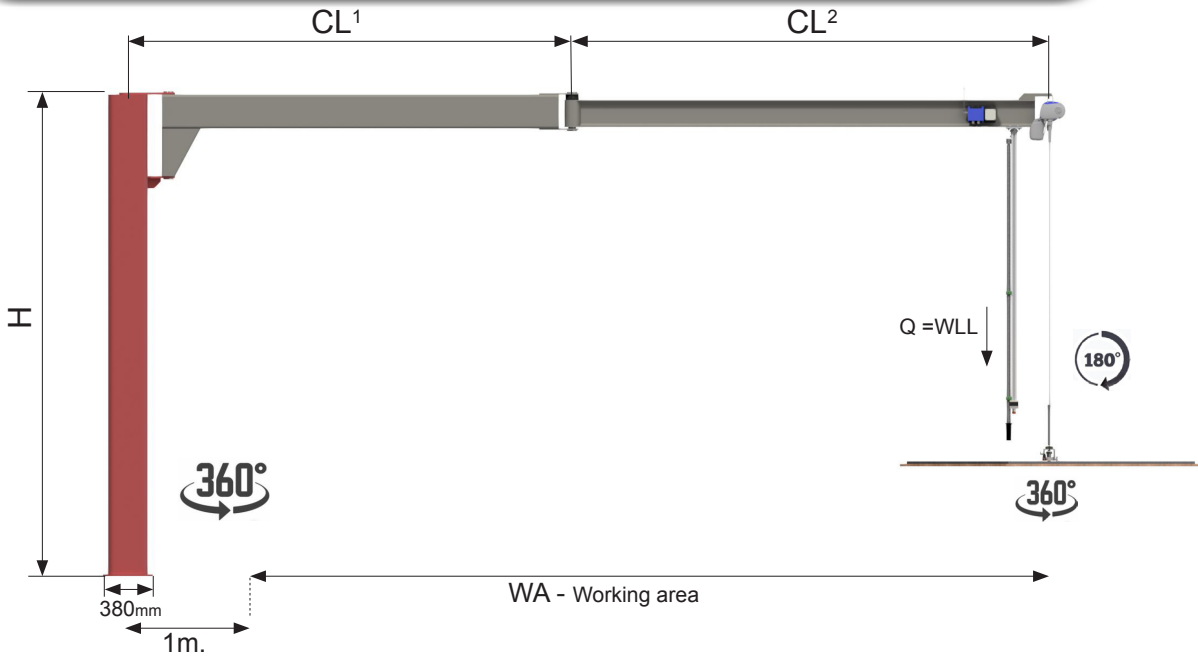

Mobilator	Measure/WLL
• Q	• 60 kg
• CL <sup>1</sup>	• 3500 mm
• CL <sup>2</sup>	• 3500 mm
• H	• 3500 mm
• WA	• 6000 mm
	• Measure is based on a standard crane

The JIP crane can be set up on almost all concrete floors and requires a minimum space of installation.

- Concrete floor is minimum 100 mm
- $f_2$  25 N/mm<sup>2</sup>
- Concrete must be free of cracks

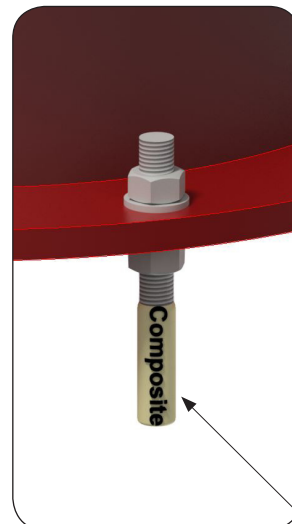
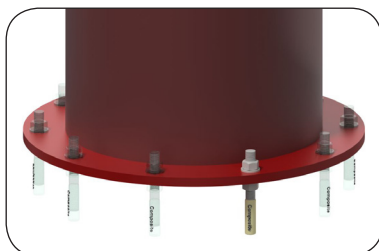

Composite Anchor

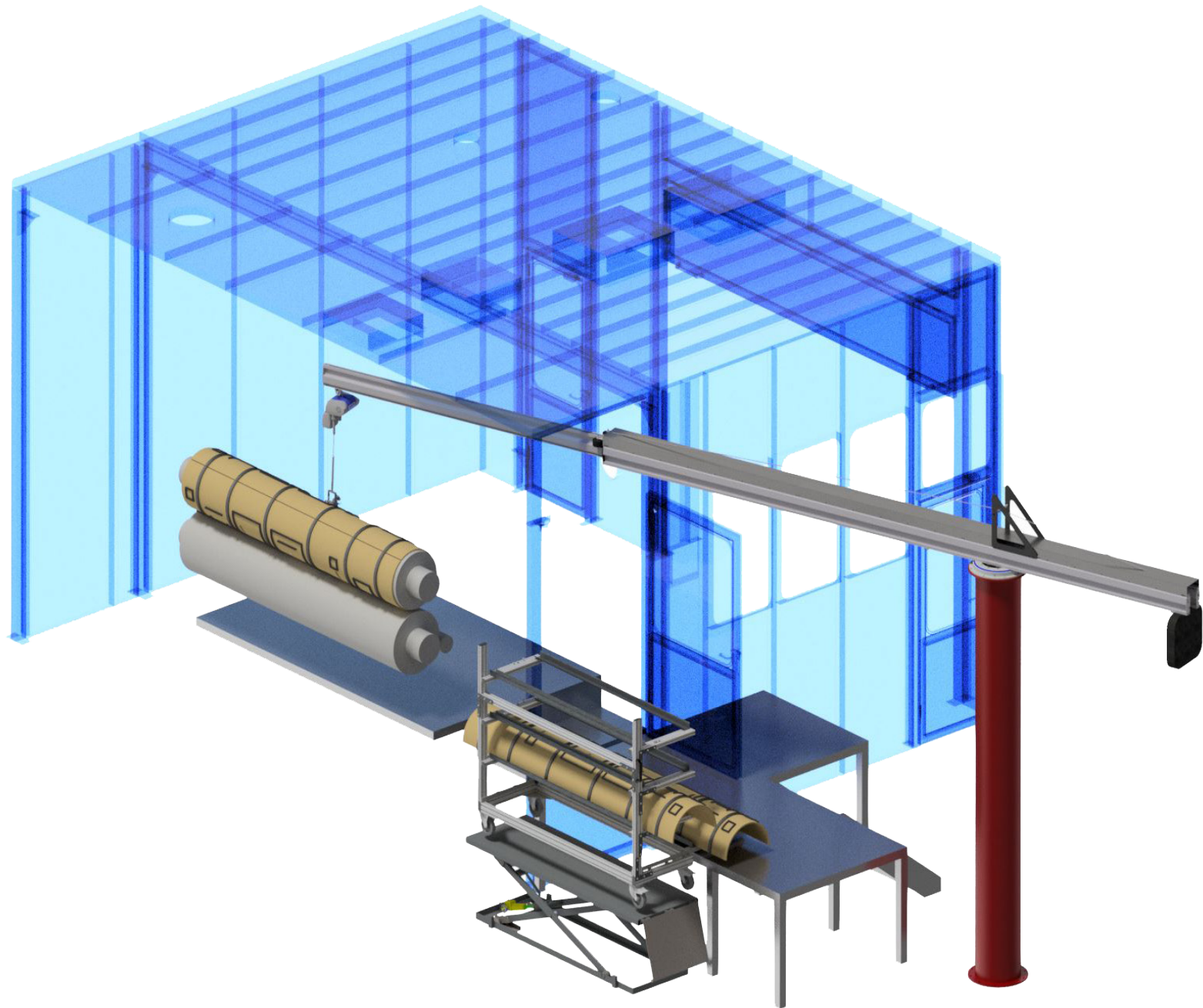

Telescoping JIB crane handling rotary dies from the rotary trolley directly into the die cutting machine



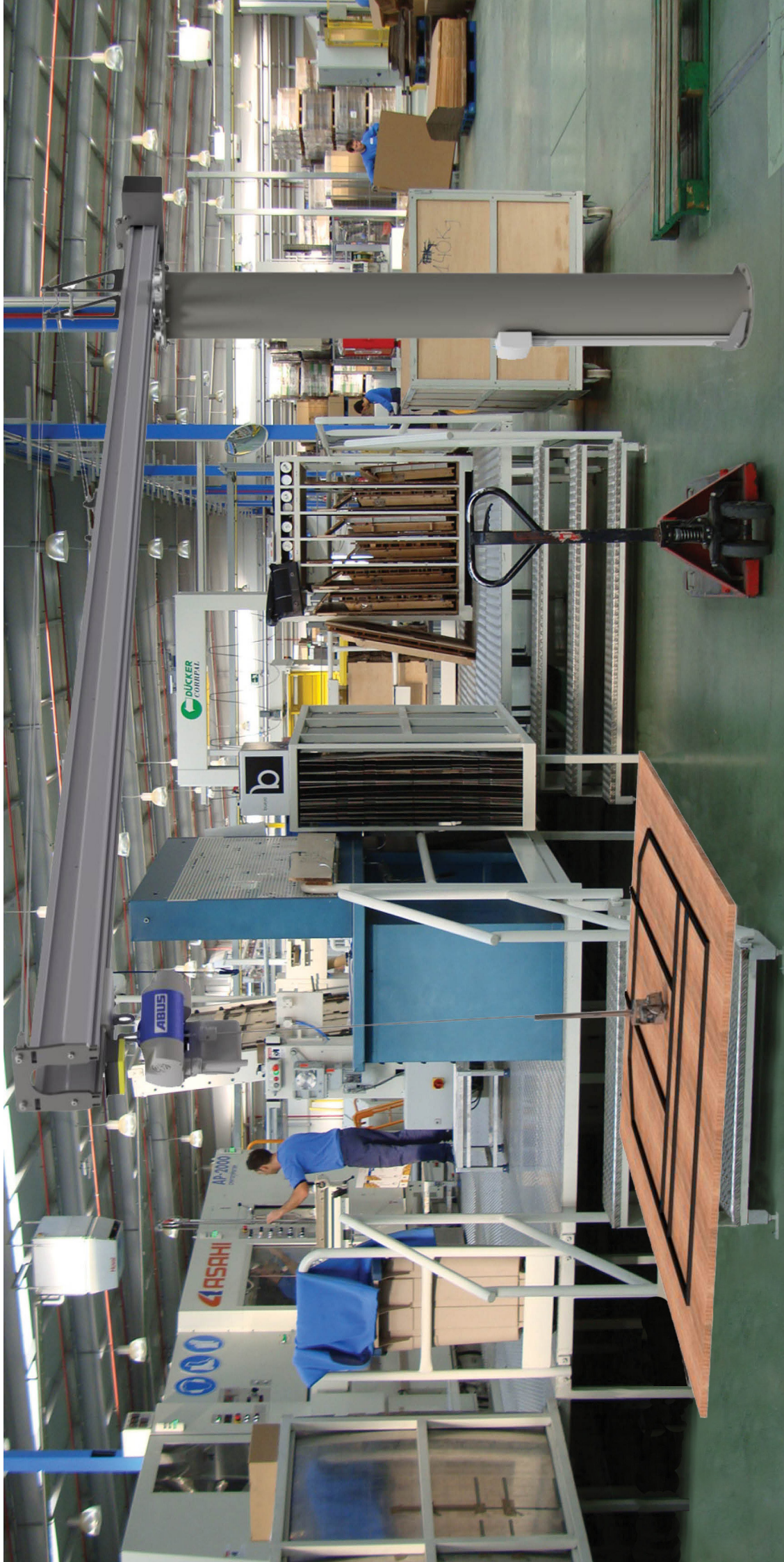

JIB crane handling flat bed die to the turntable

## England

BHS Corrugated Ltd.  
The Granary  
Congresbury  
Bristol  
BS49 5EB  
Phone : +44 (0) 19 34 839 900  
sales@bhs-corrugated.co.uk

---

## France, Spain, Portugal

Propco SAS  
148 rue des Vignes  
26400 EURRE  
Phone : +33 (0) 4 75 76 77 26  
propco@propco-sas.com  
www.propco-sas.com

---

## Germany, Switzerland Austria

Corrugated Solutions  
Hahngericht  
D-58135 Hagen  
Phone : +49 (0) 17 17 71 45 54  
matthias.olbrich@corrugated-solutions.com

---

## Benelux and Poland

Corrusystems  
Mazurkastraat 2  
7323 KE Apeldoorn  
Phone : +31 612372900  
mtermaat@corrusystems.nl

---

## South America

Francisco Appel Consulting  
Marderweg 15  
D-73230 Kirchheim unter Teck  
Phone: +49 (0) 171 304 6395  
francisco.appel@appel-diecutting.com

---

## Turkey

FEYZİ MATBAA VE GIDA SANAYII MAKINALARI  
MÜMESSİLLİK VE TİCARET A.Ş.  
Kasap Sokak Gamze Apt. No.19/A  
TR-34394 Esentepe - ISTANBUL  
Phone: +90 212 288 60 54  
feyzi@feyzi.com

---

## Australia, New Zealand

Paper Converting Machinery  
Specialists Pty. Ltd.  
340 Running Creek Road  
Arthurs Creek - Vic. 3099  
Australia  
Phone : +61 (03) 9714 8073  
sales@pcms.com.au

## Sweden

BORIN AB  
Spårgatan 2  
Box 656 SE-601 15  
Norrköping  
Sweden  
Phone : +46 11-19 06 30  
Info@borin.se

---

## USA, Canada

Hitek Equipment Inc.  
8920 58th Place #700  
Kenosha, WI 53144  
USA  
Phone : 001 262-842-1700  
sales@askhitek.com

---

## Italy

Rotalaser  
Via Angela Vacchi 16/18  
04011 Aprilia (LT)  
Phone : +39.06.927.27.883  
marcovisani@rotalaser.it

---

## Russia

"VD-Com" LLC  
Russia, Moscow, Kulakova 20 str.  
+7 (495) 966-3861  
+7 (495) 737-8807  
sales@vd-com.ru

---

## Israel

CartGO (2006) Ltd.  
Halivne 9 , Timrat 36576  
Phone: +972(0)4-6041073  
Mobile: +972(0)54-2273398  
cartgo@012.net.il

---

## Ukraine

Galpolyflex  
79059, м. Львів, вул. Перфецького, 21/58  
Phone/Fax: 032 263 73 82  
Mobile: 067 370 78 10  
sales@galpolyflex.com

---

## Denmark, Norway, Finland

bcm transtech as  
Industrivej 3  
DK - 5672 Broby  
Phone : +45 62 63 23 93 or +45 40 84 23 93  
bcm@bcm.dk